



Grid Solutions
a GE and Alstom joint venture

PROTECTION PRODUCT SOLUTIONS

MiCOM P746 Agile

Numerical busbar protection

The MiCOM P746 Agile centralized numerical busbar protection provides complete protection for all voltage levels up to extra voltage busbar configurations.



MiCOM P746 in 80TE

CUSTOMER BENEFITS

- Fast fault trip (typically 11-15 ms and 17 ms)
- 2 zones + Check Zone
- Synchronous or sequential trip
- Adapted to simple busbar configurations
- IEC 61850-8.1 compliant
- IEC 61850-9-2 LE process bus ready in one box solution
- Can operate with different types of CT
- Programmable function keys, hotkeys and tri-colour LEDs
- Redundant communications with zero downtime using optional PRP technology

A combination of security, speed and high sensitivity

Proven techniques and dynamic topology processing algorithms offer a combination of security, speed and high sensitivity.

With a typical operating time of 12 ms with HB/HS contact option, or 17 ms with standard contacts, the P746 protection is one of the fastest in its class. Moreover, the trips can be synchronous or sequential. Fully compatible with the IEC 61850-8.1, Courier, DNP3.0, Modbus, IEC103 and 9-2 LE protocols, the P746 is easily integrated into any substation system. The substation replica processing algorithms ensure that the P746 adapts to the dynamically changing topology of the busbar, which can be displayed on any PC via the substation real time dynamic monitoring tool.

The MiCOM P746 Agile differential busbar protection provides a centralised 1-box or 3-box architecture and is very simple to use: It does not need to be heavily engineered and supports easy operations and maintenance of the busbar.

MiCOM Agile P40 series extends IEC 61850-8-1 station bus to include Parallel Redundancy Protocol (PRP), which offers a vendor-interoperable solution to implement redundant communications. It has the advantage of taking zero time to recover from a failure, as parallel alternative paths are continually operative. This compares to 25 ms or more healing time for legacy techniques such as RSTP.

About MiCOM P40 Agile

Grid Solutions' philosophy is one of continuous improvement in our products and solutions. Our emphasis on communication in MiCOM has become a focus which secures leadership in the digital substation. To mark this phase of evolution, the brand "P40 Agile" is applied to the range. P40 Agile is a mark of performance and quality, proudly available from Grid Solutions, and only from Grid Solutions.



APPLICATION

The MiCOM P746 Agile centralized numerical busbar protection has been designed to protect a wide range of busbar configurations:

- 1-box mode - P746 (Can be used with NCIT or CIT applications)
- 3-box mode – one P746 per phase. (In the 3-box mode, the units are totally independent and not linked to each other and cannot be used with NCIT applications.)

The MiCOM P746 Agile can accommodate:

Up to 2 zones plus check zone for 1 or 3-box mode and up to 4 zones for dual 1 or 3-box modes:

- 1 VT, up to 6 CTs, 6 breakers and 12 isolators with the 1-box mode solution (with NCIT and CIT)
- 2 VTs, up to 12 CTs, 12 breakers and 24 isolators with the dual 1-box mode solution (with NCIT and CIT)
- 2 VTs, up to 18 CTs, 18 breakers and 36 isolators with the 3-box mode solution (Only CIT)
- 2 VTs, up to 36 CTs, 36 breakers and 72 isolators with the dual 3-box mode solution (Only CIT)

The MiCOM P746 Agile is associated with each CT location, usually one per incomer/feeder and one or two for each bus coupler/bus section. The P746 acquires the analog signals from the associated CT and the binary signals from the auxiliary contacts of the circuit breakers and isolators.

The P746 also incorporates the main circuit breaker failure logic together with additional protection functions (dead zone, overcurrent, etc...). The P746, particularly useful in double busbar applications, allows a high number of opto inputs (up to 40) and relay outputs (up to 32), function keys and offers Ethernet or a second rear port board option.

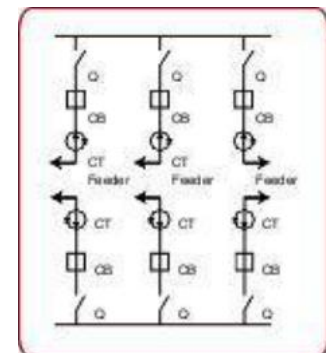
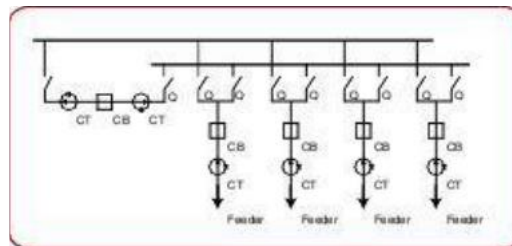
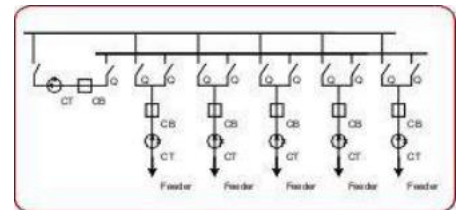
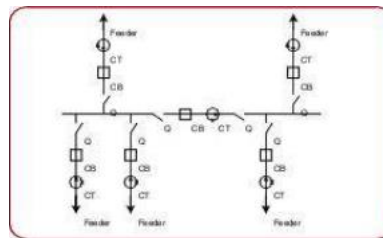
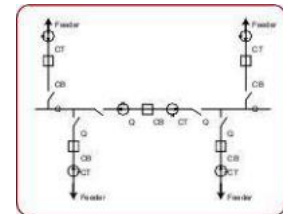
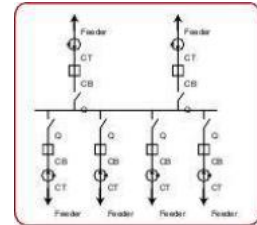
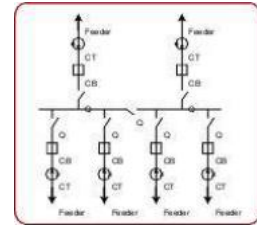

Topology scheme examples

Cost optimized to suit simple busbar configurations

ANSI	IEC 61850	FEATURES	P746
87BB / P	PhsPDIF	Phase segregated biased current differential high speed busbar protection	•
87CZ / P	CzPPDIF	Check zone segregated biased phase current differential high speed busbar protection	•
50 / 51 / P	OcpPTOC	Phase overcurrent protection (2 stages)	•
50 / 51 / N	EfmPTOC	Earth overcurrent protection (2 stages)	•
50ST / P	DzpPhsPTOC	Dead zone phase protection (short zone between CTs and open CBs)	•
CTS		Current transformer supervision	•
VTS		Voltage transformer supervision	•
50BF	RBRF	Breaker failure protection (LBB)	•
		ISL Isolator discrepancy alarm	•
	OptGGIO	Digital inputs	16 to 40*
	RlyGGIO	Output relays	16 to 32*
		Front communications port (RS232)	•
		Rear communications port (Kbus/EIA(RS)485)	•
		Rear communications port (ethernet) *	Option
		Time synchronisation port (IRIG-B) *	Option
	FnkGGIO	Function keys	10
	LedGGIO	Programmable tri-colour LEDs	18

* Refer data sheet for model selection

MANAGEMENT FUNCTIONS

In addition to the protection and control elements, the P746 provides a wide range of measurement, monitoring, post fault analysis and self-diagnostic features:

- Trip circuit supervision (using PSL)
- On-line measurement
- Plant status monitoring
- 4 alternative settings groups
- Programmable logic (PSL)
- Sequence of event recording (SOE)
- Comprehensive fault records
- Comprehensive disturbance recording (waveform capture)
- User configurable function keys & hotkeys
- User configurable tri-colour LEDs
- Local and remote communications ports
- Time synchronisation
- Fully customizable menu texts
- Multi-level password protection
- Test facilities

- Power-up diagnostics and continuous self-monitoring of relay
- User friendly settings, analysis and monitoring software

FUNCTIONAL OVERVIEW

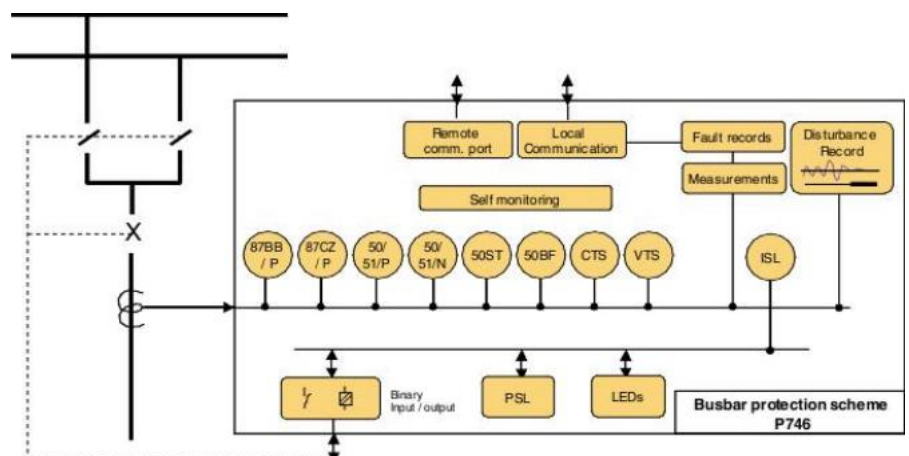

BUSBAR DIFFERENTIAL PROTECTION

The primary protection element of the P746 is the phase segregated biased current differential protection. The technique is based on the numerical application of Kirchoff's Law for the selective detection and high-speed isolation of a faulty section of the busbar. To ensure the adaptability of the relay to any type of busbar configuration, the P746 is built with a universal topology processing algorithm. This algorithm determines the optimum tripping zone based on the current status of the plant isolators or/and circuit breakers.

The P746 employs biased differential algorithms where the differential current is compared with a bias current. This characteristic ensures the stability of the protection for external faults, even with differing CT tolerance and errors which could lead to spurious operation.

To increase the security of the differential protection, the biased differential element is supervised by a biased global check zone element. This ensures stability even under erroneous status of the auxiliary contact of plant isolators and circuit breakers.

The MiCOM P746 Agile also employs CT supervision and an innovative external fault detection algorithm - the current phase comparison. This ensures stability when CTs become saturated. This technique is heavy CT saturation proof and still trips on evolving to an internal fault.

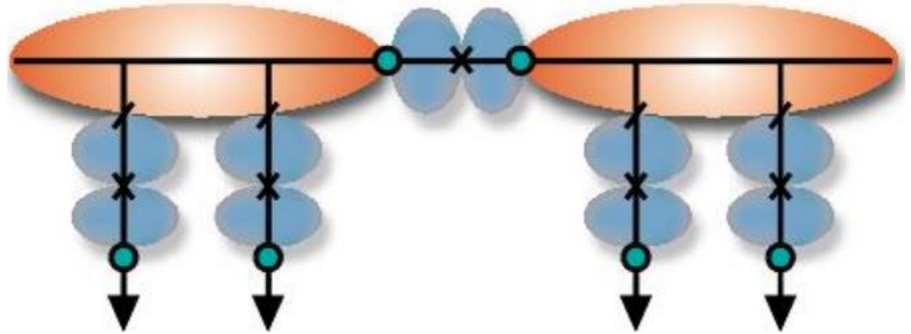

Universal on-line topology processing

MULTIPLE TRIPPING CRITERIA

The P746 maintains the highest level of stability under all conditions, including hardware failure and incoherent signals applied from external plant or generated by the power system. Any tripping order must therefore be made conditional to the simultaneous occurrence of at least five criteria:

Magnitude criteria

Confirmation of two simultaneous thresholds per zone:

- Exceeding the bias slope characteristic ($k2$)
- Exceeding differential operating current threshold ($ID > 2$)

Check zone supervision

The zone element(s) are only permitted to trip if the order is confirmed by the check zone element:

- Exceeding the bias slope characteristic (kCZ)
- Exceeding differential operating current threshold ($IDCZ > 2$)

Current phase comparison criteria

Optional voltage criteria

- Undervoltage U
- Negative sequence overvoltage $V2 >$ OR
- Zero sequence overvoltage $3V0 >$

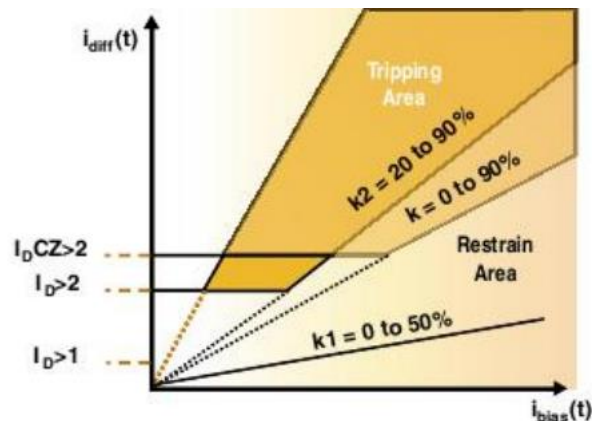
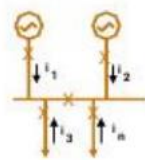

$$\text{Differential current: } i_{diff\ node}(t) = i_1 + i_2 + i_3 + \dots + i_n$$

$$\text{Operating current: } i_{diff}(t) = |i_{diff\ node}(t)| \cdot |Z|$$

$$\text{Bias current: } i_{bias}(t) = |i_1| + |i_2| + |i_3| + \dots + |i_n| \cdot Z |i_n|$$

Bias differential characteristics

SYNCHRONOUS OR SEQUENTIAL TRIPPING

The P746 allows delaying every or each tripping contact. This is highly recommended for high speed disconnection of the bar from the grid and delayed trip of the generation feeders.

DEAD ZONE OR BLIND SPOT PROTECTION

The current transformers or the open isolators surrounding the busbars define the limits of the main zones. When a feeder isolator is opened, a dead zone or blind spot is created to the associated CT. The P746 detects this condition automatically and provides protection for this zone. One stage of definite time delayed overcurrent and earth fault protection is also provided.

CONTINUOUS SUPERVISION OF CURRENT CIRCUITS

The P746 detects any abnormality in the current circuit by continuously monitoring it. Under normal operating conditions the differential current will be negligible. An anomaly is detected by a threshold, $ID > 1$, which can be set to alarm from 10 A primary.

CONTINUOUS SUPERVISION OF CURRENT CIRCUITS

Current transformer supervision is provided to detect loss of phase CT input signals. Using the "differential CTS" feature (patented), the relay performs an intelligent comparison of the negative sequence current imbalance at all CT terminals to determine which, if any, CTs have failed. This comparison detects all CT shorts, open circuits and wiring disconnections without an inherent time delay. Operation of the differential protection can be blocked during the failure, or alternatively, temporarily desensitized to avoid an unwanted trip. The CTS thus assures real-time stability of differential elements.

DIFFERENTIAL CURRENT SETTINGS

When switching operations are carried out in the substation, incorrect topology replicas may occur. In this case, a differential current appears. The differential elements of the MiCOM P746 Agile are allowed to operate only if the differential current reaches a threshold $ID > 2$, which is normally set above the highest load current when no voltage criteria is used.

PHASE OVERCURRENT AND EARTH FAULT PROTECTION

Two independent stages of phase overcurrents and earth fault protection are provided in the MiCOM P746 Agile. These elements provide additional protection for the individual circuits. The two stages can be programmed as:

- First stage can be programmed as definite time (DT) delay or one of the nine inverse time (IDMT) curves (IEC/ UK and IEEE/ US)
- Second stage can only be programmed as definite time

CIRCUIT BREAKER FAILURE PROTECTION (LBB)

The P746 offers an in-built integrated solution for breaker failure protection. In general the breaker failure protection is executed on a per phase basis which involves the possibility of receiving tripping orders on a per pole basis. The MiCOM P746 Agile busbar protection can also work in co-ordination with external breaker failure protection relays. In this configuration, the receipt of an external breaker failure command results in the tripping of all the adjacent circuit breakers, via the topological recognition system knowing which breaker is connected to which zone.

CURRENT TRANSFORMER MIXING CORRECTION

The MiCOM P746 Agile can correct a mix between current transformer ratios over a very wide range (up to 20). Its associated user interface provides a range between 1 A and 30,000 A primary. Since the current transformer ratings in a substation may be of mixed ratios, the P746 uses a virtual CT ratio equal to a settable reference current/1, irrespective of the feeder section concerned.

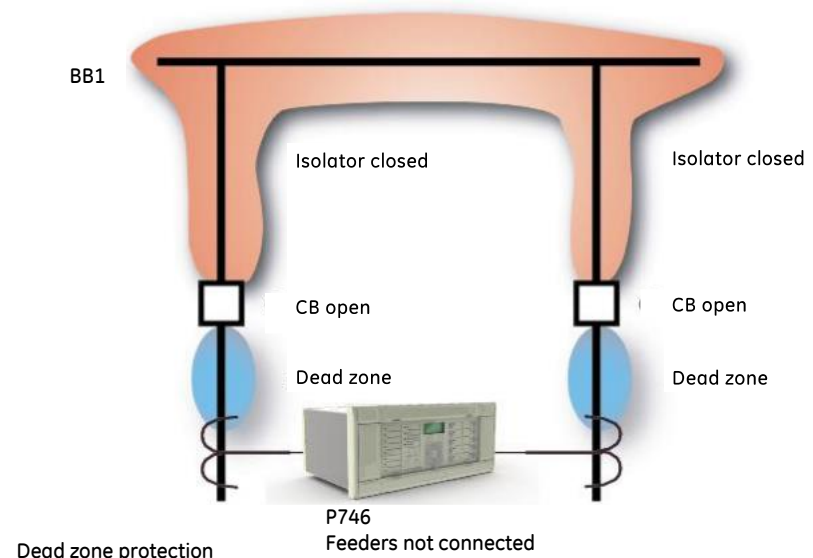

ISOLATION AND MAINTENANCE OPERATING MODE

For ease of operation or maintenance of the busbar protection system, the P746 can receive specific commands designed to allow system testing or other interventions without any danger of unwanted tripping. In the MiCOM P746 Agile, a centralized command to isolate the busbars can be selectively applied per zone:

- Differential protection (87BB) and circuit breaker failure protection (50BF) blocked.
- The additional local protection functions (51, 51N, etc...) remain operational.

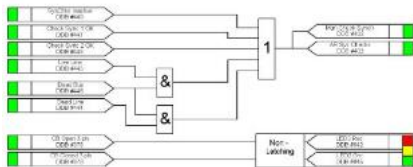

Programmable scheme logic editor (MiCOM Grid Solutions S1 Agile)

PROGRAMMABLE SCHEME LOGIC

Powerful programmable logic (PSL) allows the user to customize the protection and control functions. It is also used to program the functionality of the optically isolated inputs, relay outputs and tri-colour LED indications. The programmable logic comprises gate logic and general purpose timers. The gate logic includes OR, AND and MAJORITY gate functions, with the ability to invert the inputs and outputs and provide feedback. The programmable logic is configured using the graphical MiCOM S1 Agile software.

PLANT STATUS

Checks and monitoring of the plant status can be made and an alarm raised for any discrepancy condition between the open and closed auxiliary contacts of the isolators and circuit breakers.

REMOTE HMI

The real time remote HMI software allows the user to monitor the position of CBs and isolators in the busbar scheme, as well as currents, alarms, etc.

MEASUREMENT AND RECORDING FACILITIES

The P746 is capable of measuring and storing the values associated with a fault. All the events, fault records and disturbance records are time tagged to 1 ms using an internal real time clock. An optional IRIG-B port is also provided for accurate time synchronization. A lithium battery provides a back up for the real time clock and all records in the event of supply failure.

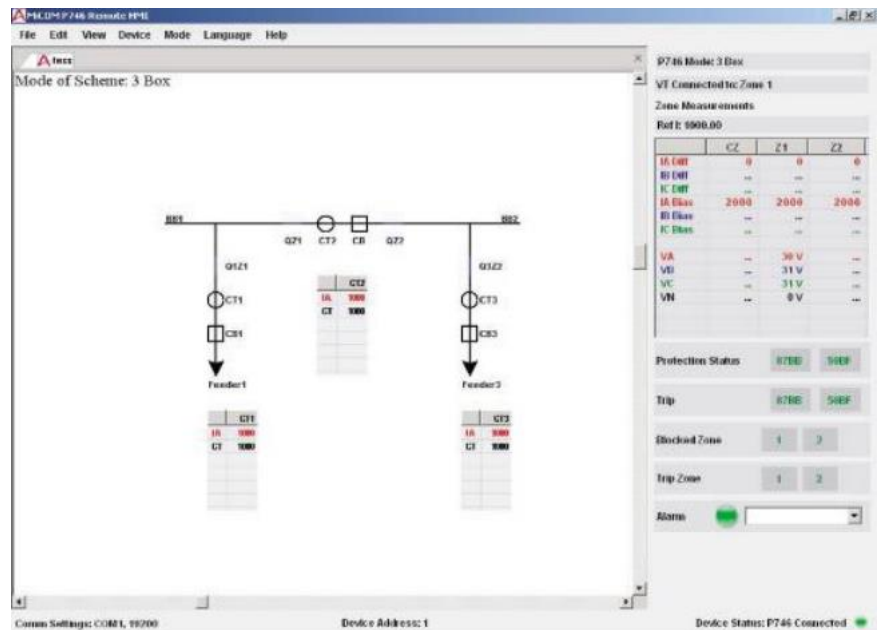

Remote HM

MEASUREMENT

The measurements provided, which may be viewed in primary or secondary values, can be accessed via the back lit liquid crystal display. They are also accessible via the communications ports. The following instantaneous parameters can be viewed:

- Phase current magnitude IA and/or IB and/or IC
- Phase current angle IA and/or IB and/or IC
- Voltage magnitude and angle
- Frequency
- Differential current Idiff / phase / zone
- Bias current Ibias / phase / zone
- Check zone Idiff / phase
- Check zone Ibias / phase

EVENT RECORDER

Up to 512 time tagged event records are stored in battery backed memory and can be extracted via the communications port or be viewed on the front panel display.

FAULT RECORDER

Records of the last five faults are stored in the battery backed memory. Each fault record includes:

- Faulted phase
- Indication of the faulty zone
- Date and time
- Active setting group
- Fault duration
- Currents, frequency and voltage

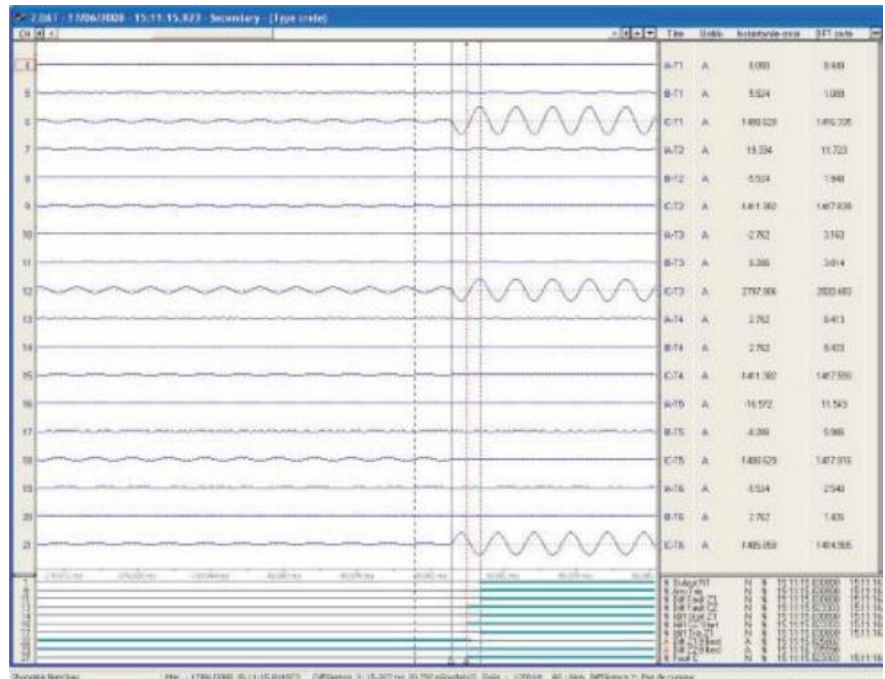

Disturbance record viewed in S1

DISTURBANCE RECORDER

The P746 has an independent disturbance recording facility. It can record 18 analogue and 32 digital channels in addition to 1 time channel.

Specific analog channels:

- VAN, VBN and VCN
- IA, IB, IC for each CT in 1-box mode
- Ix1 to Ix18 (x is A or B or C) in 3-box mode

Maximum duration of one record and number of records: up to 10.5 s per record and minimum of 50 records, 1.5 s (memory of 75 s).

Disturbance records can be extracted from the relay via the remote communications and saved in the COMTRADE format. These records may be examined using S1 or any other standard COMTRADE viewer.



Fast, sensitive & secure - P746 - the centralized solution for busbar protection

LOCAL AND REMOTE COMMUNICATIONS

Two communications ports are available as standard: a rear port providing remote communications and a front port providing local communications. As an option, an Ethernet board can be added in the P746 to use the IEC61850-8.1 protocol.

The front RS232 port is designed for use with the MiCOM S1 Agile, which fully supports functions within the relay by providing the ability to program the settings off-line, configure the programmable scheme logic, extract and view event, disturbance and fault records, view the measurement information dynamically and perform control functions (using the Courier protocol).

The default remote communications protocol is Courier / RS485 or K-bus and can be converted to IEC 60870-5-103. An optional second rear Courier communications port is available, which may be configured as RS232, RS485 or K-Bus. IEC 61850 is available when the optional Ethernet port is ordered. IEC 61850 offers high-speed data exchange, peer-to-peer communications, reporting, disturbance record extraction and time synchronization.

Redundant Ethernet is available, optionally managed by the market's fastest recovery time protocols: 'self-healing' ring and 'dual homing' star, allowing bumpless redundancy. IEC 62439 PRP and RSTP are also available, offering multi-vendor interoperability.

DEVICE TRACK RECORD

Low impedance biased differential busbar protection, MBCZ, launched in 1988 and over 7,000 cubicles sold

Over 400 modular low impedance busbar protection scheme P740 delivered since its launch in 2002

Since the launch of the P746 in 2008, over 400 systems have been delivered

IEC 61850-9-2 LE PROCESS BUS INTERFACE

An optional process bus interface is available, allowing the relay to receive current and voltage sampled data from non-conventional instrument transformers such as optical and Rogowski devices. In other digital substation architectures, the -9-2 data is generated by merging units in the yard, which digitize conventional 1 A/5 A and 100/120 V secondaries, for safer and more economical cross-site communication to IEDs by fibre optic. Grid Solutions' -9-2 implementation has been designed to be especially resilient and reliable in the presence of "noise", such as latency, jitter or missing/suspect data.

DIAGNOSTICS

Automatic tests performed, including power-on diagnostics and continuous self-monitoring, ensure a high degree of reliability. The results of the self-test functions are stored in battery backed memory. Test features available via the user interface provide examination of input quantities and states of the digital inputs and relay outputs. A local monitor port provides digital outputs selected from a prescribed list of signals, including the status of protection elements.

HARDWARE

The MiCOM P746 Agile includes:

- A back-lit liquid crystal display
- LEDs: 18 tri-colour
- Function keys
- Hotkeys
- RS232 (front port) & RS485 / K-bus (rear port)
- Optional Ethernet rear communications board or
- Optional second rear communications board
- Optional IRIG-B port
- Download/monitor port
- Battery (supervised)
- N/O and C/O watchdog contacts
- Supervised +48 V field voltage
- CT inputs 1 A and 5 A
- Universal opto inputs with programmable voltage threshold. The optically isolated inputs are independent and may be powered from the +48 V field voltage

QUALITY BUILT-IN (QBi)

Grid Solutions' QBi initiative has deployed a number of improvements to maximize field quality. Harsh environmental coating is applied to all circuit boards to shield them from moisture and atmospheric contamination. Transit packaging has been redesigned to ISTA standard, and the third generation of CPU processing boosts not only performance, but also reliability.

For more information please contact
GE Grid Solutions

Worldwide Contact Center

Web: www.GEGridSolutions.com/contact
Phone: +44 (0) 1785 250 070

www.GEGridSolutions.com

