

Multilin T60



Full-Featured, Multiple-Winding Transformer Protection

The Multilin™ T60 transformer protection system is a comprehensive three-phase transformer relay designed to protect medium and large power transformers. The T60 provides automatic or user-definable magnitude reference winding selections for CT ratio matching, and performs automatic phase shift compensation for all types of transformer winding connections.

The T60 algorithm allows the user to enable removal of the zero-sequence current even for delta connected transformer windings, accommodating transformers with a variety of grounding configurations.

Key Benefits

- Secure, high-speed protection for transformers, compliant with IEEE® C37.91 for maximum asset life
- Improved security for transformer energization and inrush provided through an adaptive 2nd harmonic restraint algorithm
- Sensitive ground fault protection provides low-impedance differential protection down to 5% of the winding to limit transformer damage
- Integrated transformer thermal monitoring for asset management and maintenance optimization
- Embedded Synchrophasor measurement capabilities (per IEEE® C37.118), eliminating the need for dedicated PMUs and support for synchrophasor multi-cast (per IEC® 61850-90-5) reducing bandwidth and communications infrastructure costs
- An integrated large, full color display, provides real-time visualization and control of the protected bay, via a bay mimic as well as annunciator functionality and graphical visualization of phasors.
- Advanced IEC 61850 Ed. 1 and Ed. 2 certified implementation, complete settings via SCL files and IEC 61850-9-2 process bus solution ensures interoperability, device managing optimization and reduced cost of ownership
- Routable GOOSE (R-GOOSE) enables customer to send GOOSE messages beyond the substation, which enables WAPC and more cost effective communication architectures for wide area applications
- Increased network availability via failover time reduced to zero through IEC® 62439-3 "PRP" support
- Supports IEEE C37.111-1999/2013, IEC 60255-24 Ed 2.0 COMTRADE standard

Applications

- Transformer asset monitoring using hottest spot, loss-of-life and aging factor
- Applicable for transformers with up to six windings in a ring bus or breaker-and-a-half configuration
- Reliable and secure protection for three-phase transformers, autotransformers, reactors, split phase and phase angle regulating transformers
- Stand-alone or component in automated substation control system

Protection & Control

- Dual-slope, dual-breakpoint differential restraint characteristic, restrained and unrestrained differential
- Transformer overexcitation overload and inhibit, thermal overload protection, 2nd Harmonic inrush
- Five-zone backup distance protection with power swing detection and load encroachment function
- Protection and control functionality in one box, reducing the number of devices
- High density inputs/outputs to support the control of many switchyard assets – all from one powerful device
- Integrated large, full color display, for real-time visualization and control of the protected bay

Cyber Security

- CyberSentry™ provides high-end cyber security aligned to industry standards and services (NERC® CIP, AAA, Radius, RBAC, Syslog)

Advanced Communications

- 3 independent Ethernet ports for simultaneous & dedicated network connections with IEEE 1588 support
- IEC 61850-9-2 process bus support
- Direct I/O for secure, high-speed exchange URs for DTT & pilot-aided schemes

Monitoring & Metering

- P&M class synchrophasors of voltage, current, and sequence components
- Advanced recording capabilities with high-capacity event recorder, configurable and extended waveform capture and data logger



Protection and Control

The T60 transformer protection system is a comprehensive three-phase transformer relay designed to protect medium and large power transformers.

As part of the Universal Relay (UR) Family, the T60 provides superior protection and control that includes:

Percent Differential Protection

The T60 provides enhanced security by including both restrained and unrestrained (instantaneous) differential protection. The percent differential element is based on a configurable dual-breakpoint/dual-slope differential restraint characteristic with inrush and overexcitation inhibits. The maximum winding current is used as a restraining signal for better through fault stability under CT saturation conditions.

Advanced CT saturation and failure detection algorithms maintain immunity to high current AC and low current DC saturation conditions that may occur due to external disturbances, such as transformer inrush or near generator faults, without sacrificing speed or sensitivity.

T60 - Protection, Metering, Monitoring and Control

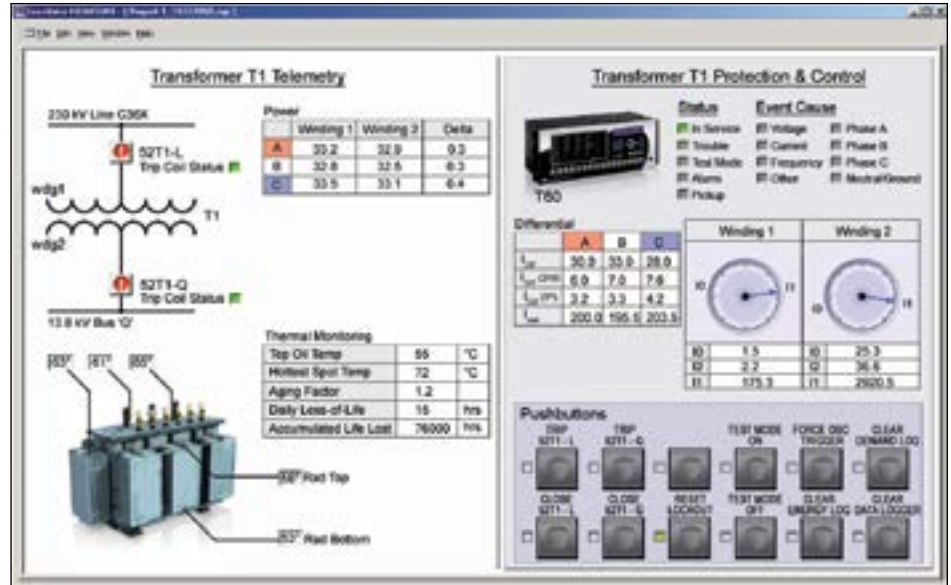

The T60 is the single point for protection, control, metering, and monitoring in one integrated device that can easily be connected directly into DCS or SCADA monitoring and control systems like Viewpoint Monitoring as shown.

Functional Block Diagram

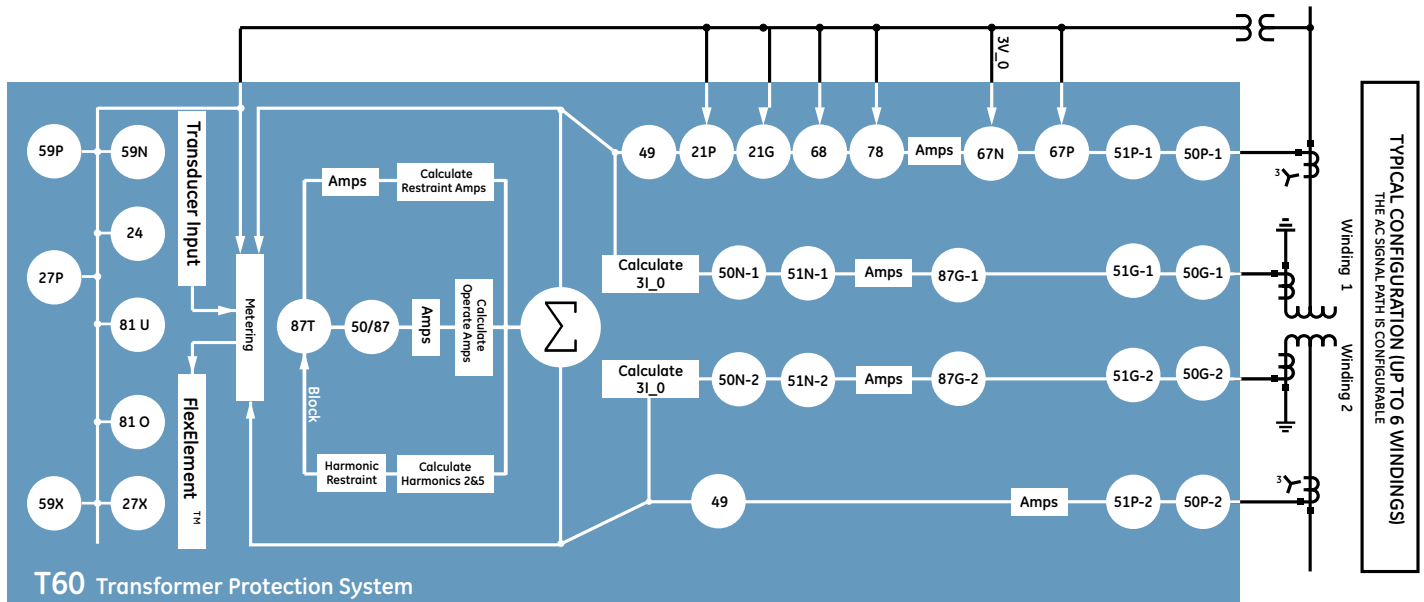

ANSI® Device Numbers & Functions

DEVICE NUMBER	FUNCTION
21P	Phase Distance
21G	Ground Distance
24	Volts Per Hertz
25	Synchrocheck
27P	Phase Undervoltage
27X	Auxiliary Undervoltage
49	Thermal Overload
50BF	Breaker Failure
50G	Ground Instantaneous Overcurrent

DEVICE NUMBER	FUNCTION
50N	Neutral Instantaneous Overcurrent
50P	Phase Instantaneous Overcurrent
50/87	Instantaneous Differential Overcurrent
51G	Ground Time Overcurrent
51N	Neutral Time Overcurrent
51P	Phase Time Overcurrent
59N	Neutral Overvoltage
59P	Phase Overvoltage
59X	Auxiliary Overvoltage

DEVICE NUMBER	FUNCTION
67N	Neutral Directional Overcurrent
67P	Phase Directional Overcurrent
68	Power Swing Blocking
78	Out-of-Step Tripping
81O	Overfrequency
81U	Underfrequency
81R	Rate of Change of Frequency (ROCOF)
87G	Restricted Ground Fault
87T	Transformer Differential

Differential vs. Restraint Characteristic (I_d vs. I_r)

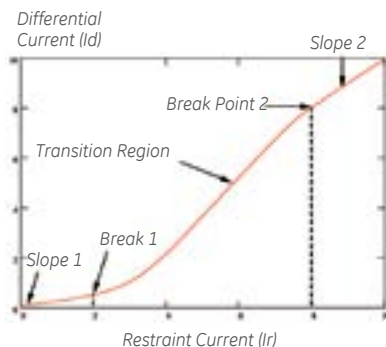

The settings for the dual-slope, dual-breakpoint characteristic provides higher flexibility for shaping up the characteristic and achieving better sensitivity and security.

Inrush Inhibit

The 2nd harmonic inhibit function is selectable in order to cover the energization of different types of transformers and can be set to either traditional or adaptive mode. The adaptive mode maximizes dependability on internal faults and ensures security during inrush conditions even with weak second harmonics. It reduces the sensitivity of magnitude comparison by biasing towards security, based on an angular relationship. Dependability is maintained by applying the restraint signal only for a period of time, dependent on the magnitude ratio.

Overexcitation Inhibit

An increase in transformer voltage or decrease in system frequency may result in overexcitation of the transformer. It is often desirable to prevent operation of the percent differential element in these cases, therefore a fifth harmonic inhibit is integrated into the percent differential element to cater to overexcitation conditions, resulting from an increased V/Hz ratio.

Unrestrained Differential

An unrestrained differential element is provided for fast tripping on heavy internal faults to limit catastrophic damage to the transformer and minimize risks to the remainder of the power system.

Restricted Ground Fault (RGF)

RGF (also known as zero-sequence differential) extends protection coverage to the neutral point of wye-connected windings where fault currents may be below the pickup of the main transformer differential elements. The low-impedance RGF protection provided in the T60 uses an optimized adaptive restraint

signal that provides security for external fault conditions that may cause CT saturation while still maintaining sensitivity for internal faults.

Distance Protection

Separate high-speed phase and ground distance elements are provided in T60 as a backup protection. T60 comes with five phase and ground distance quad and mho distance elements. The phase distance elements come with built-in in-zone transformer compensation. The T60 also provides a load encroachment element, which supervises the distance elements under heavy resistive loading conditions.

Overcurrent Functions

T60 provides thermal overload, time and instantaneous overcurrent elements for phase, neutral, ground, phase and neutral directional. The neutral directional overcurrent element supports enhanced dual polarization modes which can be configured to prioritize on voltage or current polarization. All of them can run in parallel with primary differential protection or can be programmed to provide primary protection under conditions when other protection elements are blocked.

User-Definable Protection Functions

Sixteen user-definable protection functions (FlexElements) can be programmed to respond to any quantity measured or computed by the relay (phase, ground and sequence current and voltage power, frequency, power factor, etc.) These elements respond to variations in its input signal. Applications could include: overvoltage, overpower, low power factor, temperature differential, and more.

IEC 61850 Process Bus

The IEC 61850 Process Bus module is designed to interface with the Multilin HardFiber System, allowing bi-directional IEC 61850 fiber optic communications. The HardFiber System is designed to integrate seamlessly with existing UR applications, including protection functions, FlexLogic™ metering and communications.

The Multilin HardFiber System offers the following benefits:

- Communicates using open standard IEC 61850 messaging
- Drastically reduces P&C design, installation and testing labor by eliminating individual copper terminations
- Integrates with existing T60's by replacing traditional CT/VT inputs with the IEC 61850 Process Bus module
- Does not introduce new cyber security concerns

Visit the HardFiber System product page on the GE Grid Solutions web site for more details.

Synchronism Check

The T60 provides six elements (as standard) to monitor differences in voltage magnitudes, phase angles, and frequencies taking the CB closing time into account to perform synchronism checks across breakers (up to six). The T60 can be used in conjunction with an external synchronizer as an independent check of the synchronizer prior to closing the breaker.

Advanced Automation

The T60 incorporates advanced automation features including powerful FlexLogic programmable logic, communication, and SCADA capabilities that far surpass what is

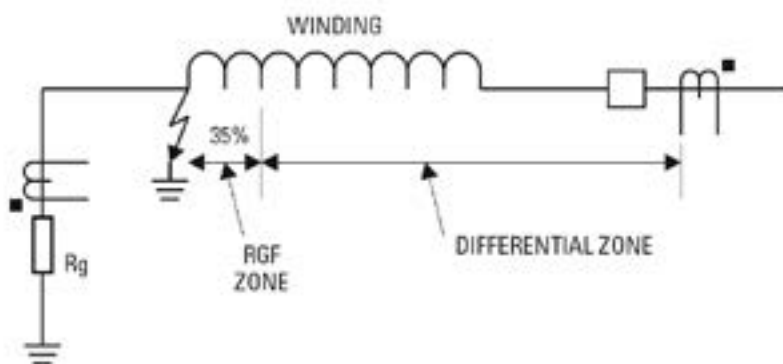

Faults close to the neutral point of a wye-connected winding does not generate adequate fault current for elements to detect. Restricted ground fault protection provides sensitive ground fault detection for low-magnitude fault currents.

found in the average transformer relay. The T60 integrates seamlessly with other UR relays for complete system protection.

FlexLogic

FlexLogic is the powerful UR-platform programming logic engine that provides the ability to create customized protection and control schemes, minimizing the need and associated costs of auxiliary components and wiring. With 1024 lines of FlexLogic, the T60 can be programmed to provide the required tripping logic along with custom scheme logic for line phase comparison (including interlocking with external synchronizers), transfer tripping schemes for remote breakers and dynamic setting group changes.

Scalable Hardware

The T60 is available with a multitude of I/O configurations to suit the most demanding application needs. The expandable modular design allows for easy configuration and future upgrades.

- Multiple CT/VT configurations allow for the implementation of many differential schemes, including concurrent split-phase and differential protection
- Types of digital outputs include trip-rated Form-A and Solid State Relay (SSR) mechanically latching, and Form-C outputs
- RTDs and DCmA inputs are available to monitor equipment parameters such as temperature and pressure

Monitoring and Metering

The T60 includes high accuracy metering and recording for all AC signals. Voltage, current, and power metering are built into

the relay as a standard feature. Current and voltage parameters are available as total RMS magnitude, and as fundamental frequency magnitude and angle. For power quality applications, harmonic measurements (up to the 25th) for voltage and current are available.

T60 can monitor, calculate and log hottest-spot temperature, aging factor and loss-of-life data over a long period. This data, combined with economic analysis, allows criteria to be developed regarding the best time at which to replace a power transformer due to load growth, i.e. to minimize the cost without significantly increasing the risk.

Fault and Disturbance Recording

The advanced disturbance and event recording features within the T60 can significantly reduce the time needed for postmortem analysis of power system events and the creation of regulatory reports. Recording functions include:

- Sequence of Event (SOE) 1024 time stamped events
- Oscillography
 - Supports IEEE C37.111-1999/2013, IEC 60255-24 Ed 2.0 COMTRADE standard
 - 64 digital & up to 40 analog channels
 - Events with up to 45s length
- Data Logger and Disturbance Recording
 - 16 channels up to 1 sample/cycle/channel
- Fault Reports
 - Powerful summary report of pre-fault and fault values
- Extensive breaker info (continuous coil monitor, arcing current, operating time, operation counter for asset management)

The very high sampling rates and large amount of storage space available for data recording in the T60 can eliminate the need for installing costly stand-alone recording equipment.

Temperature Monitoring – RTD Module Option 5C

The T60 RTD option provides 8 programmable RTD inputs per module that are used for temperature monitoring. Each RTD input has 2 operational levels: alarm and trip. The T60 supports RTD trip voting and provides open RTD failure alarming. Alternatively, a remote RTD module “RRTD”, which supports 12 RTD inputs, can also be used with the T60 for temperature monitoring. The RRTD provides cost savings when compared with traditional RTD wiring.

Advanced Device Health Diagnostics

The T60 performs comprehensive device health diagnostic at startup and continuously during run-time to test its own major functions and critical hardware. These diagnostic tests monitor for conditions that could impact security and availability of protection, and present device status via SCADA communications and front panel display. Providing continuous monitoring and early detection of possible issues help improve system uptime.

- Comprehensive device health diagnostic performed at startup
- Monitors the CT/VT input circuitry to validate the integrity of all signals
- Inputs, outputs, trip circuits and analog channels are continuously monitored for accuracy and performance

Advanced Asset Monitoring

The T60 has advanced functions that raise an alarm or trip the scheme when an internal condition in the power transformer or breaker could lead to a fault. These functions are conditions of:

- Hottest-spot temperature: element provides a mechanism for detecting abnormal winding hottest-spot temperatures inside the transformer.
- Aging factor: the aging factor element detects transformer aging in per-unit normal insulation aging.
- Loss of Life: The Loss of Life element detects the accumulated total consumed transformer life.
- Breaker arcing current: This element calculates an estimate of the per-phase deterioration on the breaker contacts by measuring and integrating the current (squared) passing through the breaker contacts as an arc.

These elements allow the user to optimize maintenance routines on the power transformer and breakers.

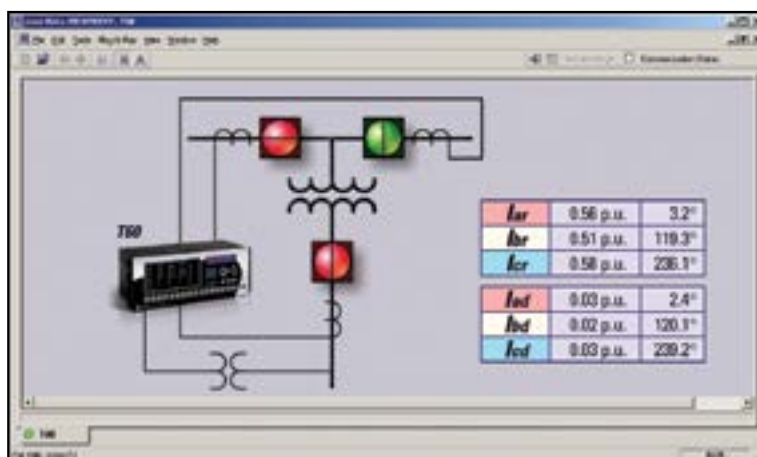

Multi-breaker application example.

Cyber Security – CyberSentry UR

CyberSentry UR enabled UR devices deliver full cyber security features that help customers to comply with NERC CIP and NIST® IR 7628 cyber security requirements.

This software option delivers the following core features:

AAA Server Support (Radius/LDAP)

Enables integration with centrally managed authentication and accounting of all user activities and uses modern industry best practices and standards that meet and exceed NERC CIP requirements for authentication and password management.

Role Based Access Control (RBAC)

Efficiently administrate users and roles within UR devices. The new and advanced access functions allow users to configure up to five roles for up to eight configurable users with independent passwords. The standard “Remote Authentication Dial In User Service” (Radius) is used for authentication.

Event Recorder (Syslog for SEM)

Capture all cyber security related events within a SOE element (login, logout, invalid password attempts, remote/local access, user in session, settings change, FW update, etc), and then serve and classify data by security level using standard Syslog data format. This will enable integration with established SEM (Security Event Management) systems.

Communications

The T60 provides advanced communications technologies for remote data and engineering access, making it the most advanced and flexible transformer protection relay to use and integrate into new and existing infrastructures. Direct support for fiber optic Ethernet provides high-bandwidth communications allowing for low-latency controls and high-speed file transfers of relay fault and event record information. The available three independent Ethernet ports, redundant Ethernet option and the embedded managed Ethernet switch provide the means to create fault tolerant communication architectures in an easy, cost-effective manner without the need for intermediary communication hardware. The T60 supports the most popular industry standard protocols enabling easy, direct integration into DCS and SCADA systems.

- IEC 61850 Ed. 1 and Ed. 2 with 61850-9-2 and 61850-90-5 support
- DNP 3.0 (serial & TCP/IP)
- Ethernet Global Data (EGD)
- IEC 60870-5-103 and IEC 60870-5-104
- Modbus RTU, Modbus TCP/IP
- HTTP, TFTP, SFTP and MMS file transfer
- IEEE 1588 and redundant SNTP for time synchronization
- PRP as per IEC 62439-3
- Supports Routable GOOSE (R-GOOSE)

Interoperability with Embedded IEC 61850 Ed. 1 and Ed. 2

The new IEC 61850 implementation in the UR Family positions GE as an industry leader in this standard.

- Implements, user selectable, Ed. 1 and Ed. 2 of the standard across the entire UR Family
- Provides full relay setting management via standard SCL files (ICD, CID and IID)
- Enables automated relay setting management using 3rd party tools through standard file transfer services (MMS and SFTP)
- Increases the number of Logical Devices and data mapped to them, GOOSE messages from up to 64 remote devices, and reports to support different organizational needs for data transfer and reduce dependency on generic logical nodes
- Configures GE Systems based on IEC 61850 using universal 3rd party tools
- Multicast IEEE C37.118 synchrophasor data between PMU and PDC devices using IEC 91850-90-5
- R-GOOSE enable customer to send GOOSE messages beyond the substation, which enables WAPC and more cost effective communication architectures for wide area applications

Direct I/O Messaging

Direct I/O allows for the sharing of high-speed digital information between multiple UR relays via direct back-to-back connections or multiplexed through a standard DSO multiplexer

Power System Troubleshooting



Record the operation of the internal T60 elements and external connected devices with 1ms time-stamped accuracy to identify the Sequence of Operation of station devices during transformer faults and disturbances.



Analyze transformer faults using both analog and digital power system quantities that are measured and recorded up to a rate of 64 samples per cycle.

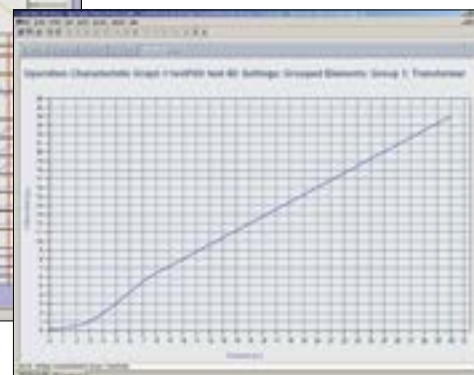

Visualization of differential characteristics allows for setting verification and operation troubleshooting.

channel bank. Regardless of the connection method, direct I/O provides continuous real-time channel monitoring that supplies diagnostics information on channel health.

Direct I/O provides superior relay-to-relay communications that can be used in advanced interlocking, generation rejection and other special protection schemes.

- Communication with up to 16 UR relays in single or redundant rings rather than simplistic point-to-point configurations
- Connect to standard DS0 channel banks through standard RS422, G.703 or IEEE C37.94 interfaces or via direct fiber optic connections
- Built-in continuous loop and channel monitoring provides real-time diagnostics of your communication channels with no external or handheld tester required

LAN Redundancy

Substation LAN redundancy has been traditionally accomplished by reconfiguring the active network topology in case of failure. Regardless of the type of LAN architecture (tree, mesh, etc), reconfiguring the active LAN requires time to switchover, during which the LAN is unavailable. UR devices deliver redundancy as specified by PRP-IEC 62439-3, which eliminates the dependency on LAN reconfiguration and the associated switchover time. The UR becomes a dual attached node that transmits data packets over both main and redundant networks simultaneously, so in case of failure, one of the data packets will reach the receiving device with no time delay.

Multi-Language

UR devices support multiple languages: English, French, Russian, Chinese, Turkish, German, Polish and Japanese. These language options are available on the front panel, in the EnerVista setup software, and in the product manuals. Easily switch between English and an additional language on the local displays without uploading new firmware.

EnerVista Software

The EnerVista suite is an industry-leading set of software programs that simplifies every aspect of using the T60 relay. The EnerVista suite provides all the tools to monitor the status of the transformer, maintain the relay, and integrate information measured by the T60 into DCS or SCADA monitoring systems. Convenient COMTRADE and SOE viewers are an integral part of the UR setup software included with every UR relay, to carry out postmortem event analysis and ensure proper protection system operation.

EnerVista Launchpad

EnerVista Launchpad is a powerful software package that provides users with all of the setup and support tools needed for configuring and maintaining Multilin products. The setup software within Launchpad allows for the configuration of devices in real-time by communicating using serial, Ethernet, or modem connections, or offline by creating setting files to be sent to devices at a later time. Included in Launchpad is a document archiving and management system that ensures critical documentation is up-to-date and available when needed. Documents made available include:

- Manuals
- Application Notes & Support Documents
- Guideform Specifications
- Brochures
- Wiring Diagrams
- FAQ's
- Service Bulletins

Viewpoint Monitoring

Viewpoint Monitoring is a simple-to-use and full-featured monitoring and data recording software package for small systems. Viewpoint Monitoring provides a complete HMI package with the following functionality:

- Plug-&-Play Device Monitoring
- System Single-Line Monitoring & Control
- Annunciator Alarm Screens
- Trending Reports
- Automatic Event Retrieval
- Automatic Waveform Retrieval

Viewpoint UR Engineer

Viewpoint UR Engineer is a set of powerful tools that allows you to configure and test GE relays at a system level in an easy-to-use graphical drag-and-drop environment. Viewpoint UR Engineer provides the following configuration and commissioning utilities:

- Graphical Logic Designer
- Graphical System Designer
- Graphical Logic Monitor
- Graphical System Monitor
- IEC 61850 Configurator

Viewpoint Maintenance

Viewpoint Maintenance provides tools that will create reports on the operating status of the relay, simplify the steps to download fault and event data, and reduce the work required for cyber security compliance audits. Tools available in Viewpoint Maintenance include:

- Settings Security Audit Report
- Device Health Report
- Single-Click Fault Data Retrieval

EnerVista Integrator

EnerVista Integrator is a toolkit that allows seamless integration of Multilin devices into new or existing automation systems. Included in EnerVista Integrator:

- OPC/DDE Server
- Multilin Drivers
- Automatic Event Retrieval
- Automatic Waveform Retrieval

User Interface

The T60 front panel provides extensive local HMI capabilities. The local display is used for monitoring, status messaging, fault diagnosis, and device configuration. User-configurable messages that combine text with live data can be displayed when user-defined conditions are met.

A 7" color, graphic HMI is optionally available that allows users to have customizable bay diagrams with local monitoring of status, values and control functionality. The alarm annunciator panel provides the configuration of up to 96 signals (alarms and status) with full text description.

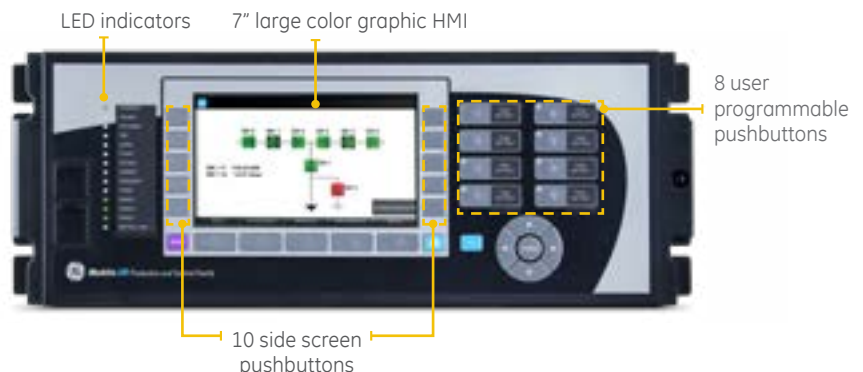

Typical Wiring

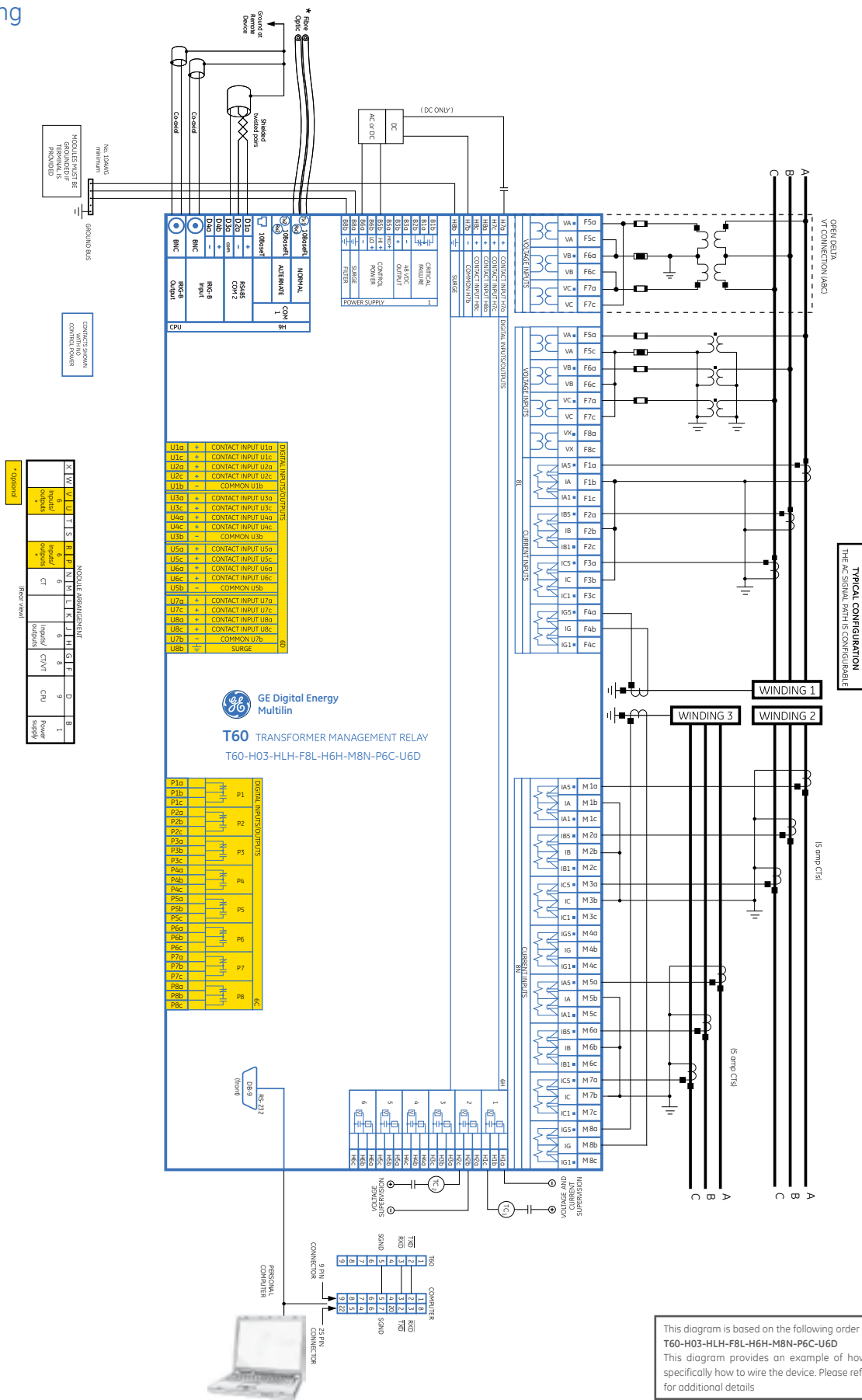

This diagram is based on the following order code:
T60-H03-HLH-F8L-H6H-M8N-P6C-U6D
 This diagram provides an example of how the device is wired, not specifically how to wire the device. Please refer to the Instruction Manual for additional details.

Ordering

	T60	*	00	-	H	*	*	-	F	**	-	H	**	-	M	**	-	P	**	-	U	**	-	W	/X	**	For Full Sized Horizontal Mount
Base Unit	T60																									Base Unit	
CPU	E J K N T U V W																									RS485 + RS485 (IEC 61850 option not available) RS485 + multimode ST 100BaseFX RS485 + multimode ST Redundant 100BaseFX RS485 + 10/100 BaseT RS485 + three multimode SFP LC 100BaseFX. Req FW v7xx or higher RS485 + two multimode SFP LC 100BaseFX + one SFP RJ45 100BaseT. Req FW v7xx or higher RS485 + three SFP RJ45 100BaseT. Req FW v7xx or higher RS485 + two 100BaseFX Eth, Multimode ST + one 10/100BaseT Eth, RJ-45 ⁵	
Software Options ^{1,3&4}	00 01 03 04 06 07 10 11 23 33 34 A0 B0 C0 D0 M0																									No Software Options Ethernet Global Data (EGD) IEC 61850 Ethernet Global Data (EGD) + IEC 61850 PMU IEC 61850 + PMU Synchrocheck Synchrocheck + IEC 61850 5 windings (No Breaker Failure) + EGD + IEC 61850 PMU + Synchrocheck PMU + IEC 61850 + Synchrocheck CyberSentry UR Lvl 1. Req UR FW 7.xx or higher IEEE 1588. Req UR FW 7.xx or higher PRP IEEE 1588 + CyberSentry. Req UR FW 7.xx or higher IEC 61850 + PMU + 61850-90-5	
Mount / Coating					H A V B																					Horizontal (19" rack) - Standard Horizontal (19" rack) - Harsh Chemical Environment Option Vertical (3/4 size) - Standard Vertical (3/4 size) - Harsh Chemical Environment Option	
User Interface						E F I J K L M N O T U V W Y H O Z X																				7" Graphical display, USB front port & programmable pushbuttons - Multi-Language (FW 7.6x or higher) Vertical Front Panel with English Display Enhanced German Front Panel Enhanced German Front Panel with User-Programmable Pushbuttons Enhanced English Front Panel Enhanced English Front Panel with User-Programmable Pushbuttons Enhanced French Front Panel Enhanced French Front Panel with User-Programmable Pushbuttons Enhanced Russian Front Panel Enhanced Russian Front Panel with User-Programmable Pushbuttons Enhanced Chinese Front Panel Enhanced Chinese Front Panel with User-Programmable Pushbuttons Enhanced Turkish Front Panel Enhanced Turkish Front Panel with User-Programmable Pushbuttons Enhanced Polish Front Panel ⁵ Enhanced Polish Front Panel with User-Programmable Pushbuttons ⁵ Enhanced Japanese Front Panel ⁵ Enhanced Japanese Front Panel with User-Programmable Pushbuttons ⁵	
Power Supply ²							H																	RH		125 / 250 V AC/DC 125/250 V AC/DC with redundant 125/250 V AC/DC 24 - 48 V (DC only)	
CT/VT DSP									8L 8M 8N 8R				8L 8M 8R													Standard 4CT/4VT w/ enhanced diagnostics Sensitive Ground 4CT/4VT w/ enhanced diagnostics Standard 8CT w/ enhanced diagnostics Sensitive Ground 8CT w/ enhanced diagnostics	
IEC 61850 Process Bus										81																8 Port IEC 61850 Process Bus Module	
Digital I/O									XX 4A 4C 4D 4L 4L 67 6C 6D 6E 6F 6K 6L 6M 6N 6P 6R 6S 6T 6U 6V 6W 6X			XX 4A 4C 4D 4L 4L 67 6C 6D 6E 6F 6K 6L 6M 6N 6P 6R 6S 6T 6U 6V 6W 6X		XX 4A 4C 4D 4L 4L 67 6C 6D 6E 6F 6K 6L 6M 6N 6P 6R 6S 6T 6U 6V 6W 6X		XX 4A 4C 4D 4L 4L 67 6C 6D 6E 6F 6K 6L 6M 6N 6P 6R 6S 6T 6U 6V 6W 6X		XX 4A 4C 4D 4L 4L 67 6C 6D 6E 6F 6K 6L 6M 6N 6P 6R 6S 6T 6U 6V 6W 6X		XX 4A 4C 4D 4L 4L 67 6C 6D 6E 6F 6K 6L 6M 6N 6P 6R 6S 6T 6U 6V 6W 6X		XX 4A 4C 4D 4L 4L 67 6C 6D 6E 6F 6K 6L 6M 6N 6P 6R 6S 6T 6U 6V 6W 6X		XX 4A 4C 4D 4L 4L 67 6C 6D 6E 6F 6K 6L 6M 6N 6P 6R 6S 6T 6U 6V 6W 6X		No Module 4 Solid State (No Monitoring) MOSFET Outputs 4 Solid State (Current w/opt Voltage) MOSFET Outputs 16 Digital Inputs with Auto-Burnish 14 Form-A (No Monitoring) Latchable Outputs 8 Form-A (No Monitoring) Outputs 8 Form-C Outputs 16 Digital Inputs 4 Form-C Outputs, 8 Digital Inputs 8 Fast Form-C Outputs 4 Form-C & 4 Fast Form-C Outputs 2 Form-A (Current w/ opt Voltage) & 2 Form-C Outputs, 8 Digital Inputs 2 Form-A (Current w/ opt Voltage) & 4 Form-C Outputs, 4 Digital Inputs 4 Form-A (Current w/ opt Voltage) Outputs, 8 Digital Inputs 6 Form-A (Current w/ opt Voltage) Outputs, 4 Digital Inputs 2 Form-A (No Monitoring) & 2 Form-C Outputs, 8 Digital Inputs 2 Form-A (No Monitoring) & 4 Form-C Outputs, 4 Digital Inputs 4 Form-A (No Monitoring) Outputs, 8 Digital Inputs 6 Form-A (No Monitoring) Outputs, 4 Digital Inputs 2 Form-A (Cur w/ opt Volt) 1 Form-C Output, 2 Latching Outputs, 8 Digital Inputs 30 Contact Inputs - Pin Terminals ⁵ 18 Form-A (No Monitoring) Outputs - Pin Terminals ⁵	
Transducer I/O									5A 5C 5E 5F				5A 5C 5E 5F		5A 5C 5E 5F		5A 5C 5E 5F		5A 5C 5E 5F		5A 5C 5E 5F		5A 5C 5E 5F		5A 5C 5E 5F		4 dcmA Inputs, 4 dcmA Outputs 8 RTD Inputs 4 dcmA Inputs, 4 RTD Inputs 8 dcmA Inputs
Inter-Relay Communications																										820 nm, multimode, LED, 1 Channel 1300 nm, multimode, LED, 1 Channel 1300 nm, singlemode, ELED, 1 Channel 820 nm, multimode, LED, 2 Channels 1300 nm, multimode, LED, 2 Channels 1300 nm, singlemode, ELED, 2 Channels G.703, 2 Channels RS422, 2 Channels IEEE C37.94, 820 nm, multimode, LED, 2 Channel C37.94SM, 1300nm singlemode, ELED, 2 Channel singlemode	

Ordering Notes:

- To view all the options available for T60, please visit GE's On-Line Store <http://store.gedigitalenergy.com/viewprod.asp?model=T60>
- Redundant power supply only available in horizontal unit. If redundant is chosen, must be same type. Maximum 2 per chassis.
- All "5 windings (No breaker Failure)" options become "6 windings w/breaker failure" when FW v7xx is chosen.
- Synchro-Check elements (25) are part of the standard features. Applies to FW version 7.4 and above
- Option available soon

GEGridSolutions.com

IEC is a registered trademark of Commission Electrotechnique Internationale. IEEE is a registered trademark of the Institute of Electrical Electronics Engineers, Inc. Modbus is a registered trademark of Schneider Automation. NERC is a registered trademark of North American Electric Reliability Council. NIST is a registered trademark of the National Institute of Standards and Technology.

GE, the GE monogram, Multilin, FlexLogic, EnerVista and CyberSentry are trademarks of General Electric Company.

GE reserves the right to make changes to specifications of products described at any time without notice and without obligation to notify any person of such changes.

Copyright 2018, General Electric Company.



imagination at work

GEA-12650LIEN
English
180606